

Varenummer: 204080M20200A0U

Beskrivelse: E+G Justerfod
GN 40-80-M20-200-A0-U

Note: U Uden møtrik, sekskant i toppen, spændeflade i bunden

Mål

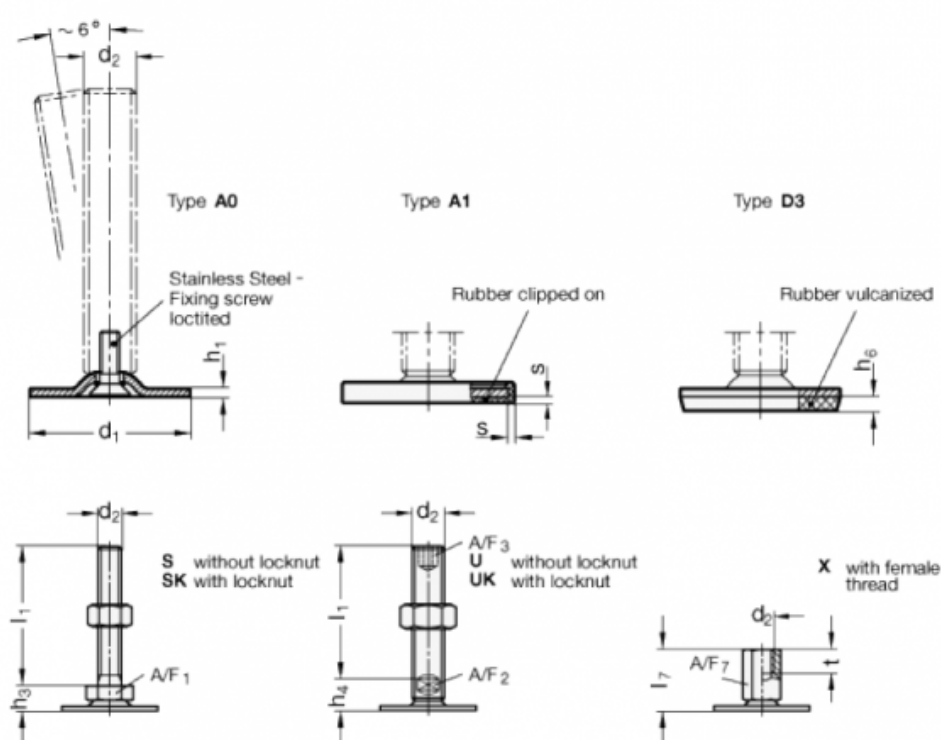

A/F2 = 15
A/F3 = 10
d1 = 80
d2 = M20
h1 = 3
h4 = 18
h6 =
l1 = 200

s =